



【 Model: FWK2421 】

General Info

The advantages are as followings:

1. According to the characteristic of LED heat dissipation, the mechanical design and thermal principle are used to carry out to structural design of luminaires, combined with the material of high-thermal conductivity of high-purity aluminum alloy and the special processing technology, the effect of heat conduction, heat convection and heat radiation has been improved significantly, so that make “WuKong” Square series luminaires to achieve much more smaller, less weight, high light efficiency, energy saving, environmental protection and low carbon innovative products.
2. With super power LED, accurately control the scattered light, so that the LED light efficiency is much more higher, the center light intensity is much more stronger , which provides a perfect solution for middle-distance projection lighting.
3. Integrated 10 ° shielding angle into the special design of luminaires.

Control: Standard DMX512 (1990) protocol compatible.

Application: Suitable for landscape lighting of square, outdoor landscape, building facade, facade lighting of individual building and historical building, landscape lighting of green plant etc.

Technical parameter

| Model | FWK2421 |
|-------------------------------|---|
| LED lifespan | 50,000 hours |
| LED quantity | 6 PCS |
| LED color(single color) | 3000K/4000K/5000K |
| Beam Angle(FWHM) | 3° |
| Shielding Angle | 10° |
| Housing | Die-cast aluminum/aluminum alloy housing, dark gray powder paint with high corrosion resistance |
| Glass material | 5mm thickness toughened ultra-white glass |
| LED driver | 2800mA constant current driver |
| Power input | 100 ~ 240VAC ± 10%, 50/60Hz; 24V DC |
| Power consumption | 65W |
| Ingress protection | IP66 |
| Power cable | 3*1.0mm ² rubber cable(High voltage); 2*1.0mm ² rubber cable(Low voltage) |
| Signal cable | CAT5-SFTP-4P(Controllable) |
| Control | DMX512(1990) |
| Classification | I;III |
| Anti-static | IEC61000-4(Level 4) |
| Ambient operating temperature | -20°C ~ +55 °C (Ta+10°C) |
| Power Factor(PF) | ≥0.9 |
| Inrush current(Max) | 50A |
| Net weight | 3.0KG |

Dimension (mm)

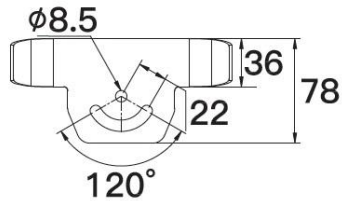
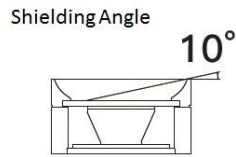
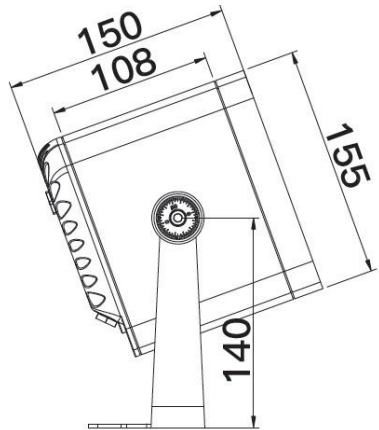
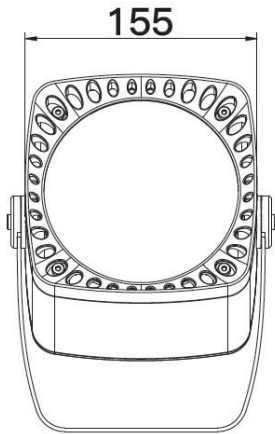

Product accessories : Outer light shield

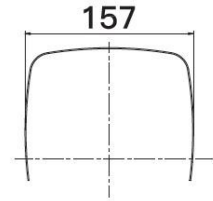
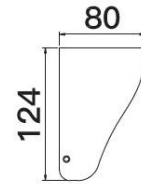

Accessories Optional

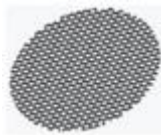

Outer light shield Honeycomb anti-glare net Deep cylinder anti-glare shield